

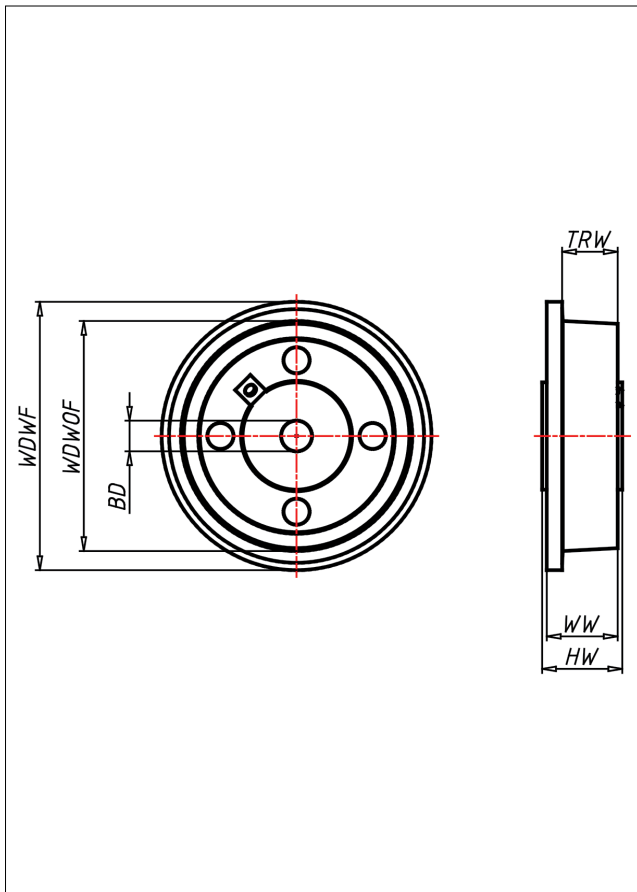

SP Spurkranzrad

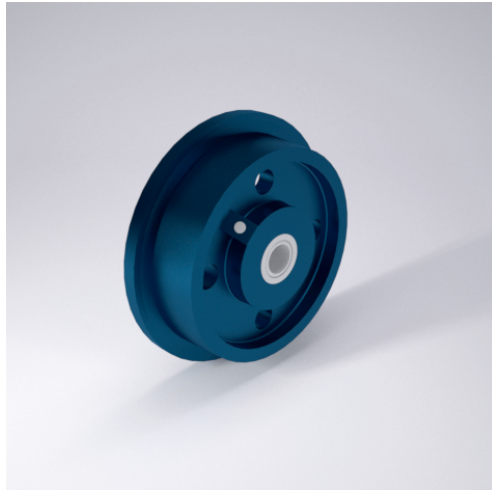

SP Spurkranzrad



Spurkranzrad aus Eisenguss
Lauffläche sauber überdreht, Neigungswinkel 3°
Ausführung lackiert

- sehr hohe Tragkraft
- sehr abriebfest
- für hohe Temperaturen

Technische Details

ORDERNO (Artikel-nummer)	125 SPK 20
WDWOF (Rad-Ø o. Spurkranz / mm)	125
WDWF (Rad-Ø m. Spurkranz / mm)	145
TRW (Laufflächenbreite / mm)	36
WW (Radbreite / mm)	46
LC (Tragkraft / kg)	900
HW (Nabellänge / mm)	52
WB (Radlager)	Kugellager
BD (Bohrungsdurchmesser / mm)	20